



EQUIPMENT RULES OF SAILING  
**2013 - 2016**

INTERNATIONAL SAILING FEDERATION  
SAILING.ORG

---

**THE  
EQUIPMENT RULES  
OF  
SAILING**

**for 2013–2016**

**International Sailing Federation**

As the leading authority for the sport, the International Sailing Federation promotes and supports the protection of the environment in all sailing competition and related activities throughout the world.

**Contact Details for the ISAF Secretariat:**

Ariadne House  
Town Quay  
Southampton  
Hampshire SO14 2AQ  
UK

**Tel** +44 (0) 23 80 635111

**Fax:** +44 (0) 23 80 635789

**Email:** [secretariat@isaf.co.uk](mailto:secretariat@isaf.co.uk)

**[sailing.org](http://sailing.org)**

Published by ISAF (UK) Ltd., Southampton, UK  
© International Sailing Federation, (IOM) Ltd.

# CONTENTS

---

Introduction .....	4
<b>Part 1 – Use of Equipment</b>	
Section A – During an Event .....	6
Section B – While Racing .....	7
<b>Part 2 – Definitions</b>	
Section C – General Definitions .....	8
Section D – Hull Definitions .....	13
Section E – Hull Appendage Definitions .....	14
Section F – Rig Definitions .....	16
Section G – Sail Definitions .....	27
Subsection A – Trilateral Sails .....	27
Subsection B – Additions for Other Sails .....	38
<b>Part 3 – Rules Governing Equipment Control and Inspection</b>	
Section H – Equipment Control and Inspection .....	40
<b>Appendix 1</b>	
Racing Rules that govern the use of equipment .....	43
Index of Defined Terms .....	44

# INTRODUCTION

---

The *Equipment Rules of Sailing* includes and references:

- Rules for use of equipment.
- Definitions of equipment, measurement points and measurements for use in **class rules** and other rules and regulations.
- Rules governing **certification control** and **equipment inspection**.

## Terminology

A term used in its defined sense is printed in “**bold**” if defined in the ERS and in “*italic*” if defined in the RRS. Other words and terms are used in the sense ordinarily understood in nautical or general use in English.

## Abbreviations

ISAF	International Sailing Federation
MNA	ISAF Member National Authority
ICA	International Class Association
NCA	National Class Association
ERS	The Equipment Rules of Sailing
RRS	The Racing Rules of Sailing

## Revision

The Equipment Rules are revised and published every four years by the International Sailing Federation (ISAF), the international authority for the sport. This edition becomes effective on 1 January 2013 except that for an event beginning in 2012 the date may be postponed by the Notice of Race and Sailing Instructions. Changes to the Equipment Rules are permitted under ISAF Regulations 32.1.2 and 32.2. No changes are contemplated before 2017, but any changes determined to be urgent before then will be announced through National Authorities and posted on the ISAF website ([sailing.org](http://sailing.org)).

## Applicability

The ERS may be made applicable by:

- (a) **Class Rules**.
- (b) Adoption in the notice of race and sailing instructions.
- (c) Prescriptions of an MNA for races under its jurisdiction.
- (d) ISAF Regulations.
- (e) Other documents that govern races.

## INTRODUCTION

---

### Changes

The ERS may only be changed as follows:

- (a) Prescriptions of an MNA may change a rule in ERS Part 1, for races under its jurisdiction.
- (b) **Class rules** may change ERS rules as permitted by rule A.1.

These restrictions do not apply if rules are changed to develop or test proposed rules in local races. The MNA may prescribe that its approval is required for such changes.

Marginal markings indicate substantial changes to the 2009 – 2012 edition.

# PART 1 – USE OF EQUIPMENT

---

In addition to the rules in Part 1, **class rules** and the *Racing Rules of Sailing* contain rules governing the use of equipment. Appendix 1 provides a list of those racing rules.

## Section A – During an Event

### A.1 CLASS RULES

**Class rules** may change rules B.1 and B.2

### A.2 CERTIFICATE

#### A.2.1 Having a Certificate

The **boat** shall have such valid **certificate** as required by its **class rules** or the **certification authority**.

#### A.2.2 Compliance with a Certificate

The **boat** shall comply with its **certificate**.

See also RRS rule 78 Compliance with Class Rules; Certificates.

## Section B – While Racing

### B.1 POSITION OF EQUIPMENT

#### B.1.1 Mast Upper Limit Mark

The **mainsail** shall be below the **mast upper limit mark**.

#### B.1.2 Mast Lower Limit Mark

When a sail is set on a **main boom**, **foremast boom** or **mizzen boom**, the extension of the upper edge of the **spar** shall intersect the mast **spar** above the **mast lower limit mark**, with the boom **spar** on the mast **spar** centreplane and at 90° to the mast **spar**.

#### B.1.3 Boom Outer Limit Mark

The **leech** of any sail set on a **boom**, extended as necessary, shall intersect the upper edge of the boom **spar** forward of the **boom outer limit mark**.

#### B.1.4 Bowsprit Outer Limit Mark

The **tack** of any **headsail** set on a **bowsprit** shall be attached aft of the **bowsprit outer limit mark**.

#### B.1.5 Bowsprit Inner Limit Mark

The **bowsprit inner limit mark** shall not be outboard the **hull** when the **bowsprit** is set.

### B.2 HEADSAIL BOOMS

The fore end of a **headsail boom** shall be approximately on the boat centerplane.

### B.3 SPINNAKER STAYSAILS AND MIZZEN STAYSAILS

The **tack** of a spinnaker staysail or **mizzen** staysail shall be inboard the **sheerline**.



# PART 2 – DEFINITIONS

---

## Section C – General Definitions

### C.1 CLASS

#### C.1.1 Class Authority

The body that governs the class as specified in the **class rules**.

### C.2 RULES

#### C.2.1 Class Rules

The rules that specify:

the **boat** and its use, **certification** and administration.

the **crew**.

**personal equipment** and its use, **certification** and administration.

**portable equipment** and its use, **certification** and administration.

any other equipment and its use, **certification** and administration.

changes to the Racing Rules of Sailing as permitted by RRS 86.1(c).

The term includes rules of handicap and rating systems.

#### C.2.2 Closed Class Rules

**Class rules** where anything not specifically permitted by the **class rules** is prohibited.

#### C.2.3 Open Class Rules

**Class rules** where anything not specifically prohibited by the **class rules** is permitted.

#### C.2.4 Class Rules Authority

The body that provides final approval of the **class rules**, **class rule** changes and **class rule** interpretations.

### C.3 CERTIFICATION

#### C.3.1 Certification Authority

For the **hull**: the ISAF, the MNA of the owner, or their delegates.

For other items: the ISAF, the MNA in the country where the **certification** shall take place, or their delegates.

#### C.3.2 Certify/Certification

To issue a **certificate**, or apply a **certification mark** after successful **certification control**.

**C.3.3 Certificate**

Documentary proof, issued by the **certification authority**, of successful **certification control** of the **hull**, or any other parts required by the **class rules** or a **certification authority**.

The term includes handicap and rating certificates.

**C.3.4 Certification Mark**

Proof of successful **certification control** of a part requiring **certification** applied as required by the **class rules** or a **certification authority**.

**C.4 CERTIFICATION CONTROL AND EQUIPMENT INSPECTION**

See H.1 and H.2.

**C.4.1 Fundamental Measurement**

The methods used as the primary means to establish the physical properties of equipment.

**C.4.2 Certification Measurement**

The methods used as means of equipment control required by **class rules**, or a **certification authority**, for **certification**.

**C.4.3 Equipment Inspection**

Control carried out at an event as required by the notice of race and the sailing instructions which may include **fundamental measurement**.

**C.4.4 Official Measurer**

A person appointed or recognised, by the MNA of the country where the control takes place, to carry out **certification control** and when the **class rules** permit, **certification**. An MNA may have delegated this responsibility.

**C.4.5 In-House Official Measurer**

An **official measurer** appointed in accordance with the ISAF In-House Certification Programme.

**C.4.6 Equipment Inspector**

A person appointed by a race committee to carry out **equipment inspection**.

**C.4.7 Limit Mark**

A clearly visible mark of a single colour, contrasting to the part(s) on which it is placed, indicating a measurement point.

**C.4.8 Event Limitation Mark**

A mark placed by a race committee on equipment whose replacement at the event is controlled by the **class rules**.

## C.5 PERSONAL DEFINITIONS

### C.5.1 Crew

A competitor, or team of competitors, that operates a **boat**.

### C.5.2 Skipper

The **crew** member on-board who is in charge of the **boat** and the **crew** and all other persons aboard.

### C.5.3 Personal Equipment

All personal effects carried or worn and items worn on board to keep warm and/or dry, and/or to protect the body, **personal flotation device**, safety harnesses and hiking aids worn to keep the person aboard or afloat.

### C.5.4 Personal Flotation Device

**Personal equipment** as required by the *rules* to assist the user to float in water.

## C.6 BOAT DEFINITIONS

### C.6.1 Boat

The equipment used by the **crew** to take part in a race.

It includes:

**hull(s)**

structure(s) connecting **hulls**

**hull appendage(s)**

**ballast**

**rig**

**sail(s)**

fittings

boat **corrector weights** and

all other items of equipment used

but excludes

consumables

**personal equipment** and

**portable equipment.**

### C.6.2 Boat Types

(a) MONOHULL

A **boat** with one **hull**.

(b) MULTIHULL

A **boat** with more than one **hull**.

(c) WINDSURFER

A **boat**.

(d) KITE-BOARD

A **boat**.

### C.6.3 Boat Control Definitions

(a) MAJOR AXES

The three major axes of the boat at 90° to each other – vertical, longitudinal and transverse – shall be related to the baseline and the hull centreplane.

See H.3.

(b) MEASUREMENT TRIM

Measurement trim is achieved when either, as specified in **class rules**,

(i) two points on the **hull(s)** are at set distances perpendicular to a plane – the plane, the points and distances to be specified in **class rules**,

or

(ii) as determined by flotation with the **boat** in the condition as specified in **class rules**.

(c) WATERLINE

The line(s) formed by the intersection of the outside of the **hull(s)** and

(i) a plane specified in the **class rules**,

or

(ii) the water surface when the **boat** is floating in **measurement trim**.

(d) WATERPLANE

The plane passing through the **waterline**.

(e) BALLAST

Weight installed to influence the stability, flotation or total weight of the **boat**.

**Ballast** types:

(i) INTERNAL BALLAST

**Ballast** positioned inside a **hull**.

(ii) EXTERNAL BALLAST

**Ballast** positioned outside a **hull**.

(iii) MOVEABLE BALLAST

Internal **ballast** or external **ballast** that may be moved.

(iv) VARIABLE BALLAST

Water **ballast** the amount of which may be varied.

(v) CORRECTOR WEIGHT

Weight installed in accordance with the **class rules** to correct deficiency in weight and/or its distribution.

### C.6.4 Boat Dimensions

(a) BOAT LENGTH

The longitudinal distance between the aftermost point and the foremost point of the **boat** with **sails** and **spars** set as appropriate.

See H.3.4.

(b) BOAT BEAM

The transverse distance between the outermost points of the **boat**.

(c) WATERLINE LENGTH

The longitudinal distance between the aftermost point and the foremost point of the **waterline**.

(d) WATERLINE BEAM

The transverse distance between the outermost points of the **waterline**.

(e) DRAFT

The vertical distance between the **waterplane** and the lowest point of the **boat**.

(f) MINIMUM DRAFT

The **draft** with all **hull appendages** in their highest position.

(g) MAXIMUM DRAFT

The **draft** with all **hull appendages** in their lowest position.

(h) BOAT WEIGHT

The weight of the **boat**.

**C.6.5 Portable Equipment**

Equipment permitted by **class rules** excluding:

the **boat**,

**personal equipment**, and

consumables.

Typical examples of portable equipment would include, mooring lines, paddles and bailers.

## Section D – Hull Definitions

### D.1 HULL TERMS

#### D.1.1 Hull

The shell including any transom, the deck including any superstructure, the internal structure including any cockpit, the fittings associated with these parts and any **corrector weights**.

#### D.1.2 Sheerline

The line formed by the intersection of the top of the deck and the outside of the **hull** shell, each extended as necessary.

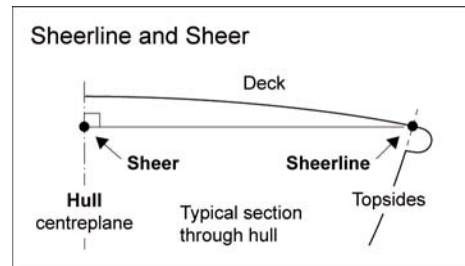

#### D.1.3 Sheer

The projection of the **sheerline** on the centreplane.

### D.2 HULL MEASUREMENT POINTS

#### D.2.1 Hull Datum Point

A point on the **hull** specified in the **class rules** from which **hull** measurements can be taken.

### D.3 HULL DIMENSIONS

#### D.3.1 Hull Length

The longitudinal distance between the aftermost point and the foremost point on the **hull(s)**, excluding fittings.

See H.3.4.

#### D.3.2 Hull Beam

The maximum transverse distance between the outermost points of the **hull(s)** excluding fittings.

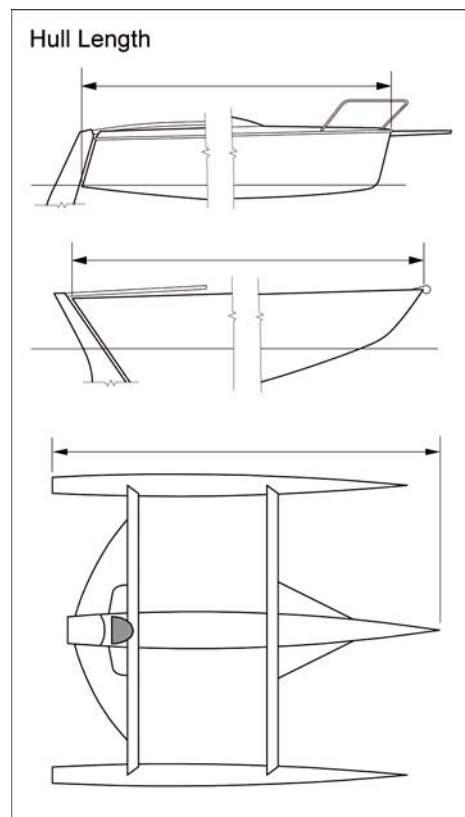

### D.4 WEIGHT

#### D.4.1 Hull Weight

The weight of the **hull**.

## Section E – Hull Appendage Definitions

### E.1 HULL APPENDAGE TERMS

#### E.1.1 Hull Appendage

Any item of equipment – including the items listed in E.1.2– which is:  
wholly or partly below the **sheerline** or its extension when fixed or when fully exposed if retractable,  
attached to the **hull** shell or another **hull appendage**, and  
used to affect: stability, leeway, steerage, directional stability, motion damping, trim, displaced volume,

Any of the following shall be included in the **hull appendage**:

**corrector weights**,  
integral **ballast**, and  
associated fittings.

#### E.1.2 Hull Appendage Types

(a) KEEL

A fixed **hull appendage**, attached approximately on the **hull** centreplane, primarily used to affect stability and leeway.

(b) BILGE KEEL

A fixed **hull appendage**, attached off the **hull** centreplane, primarily used to affect stability and leeway.

(c) CANTING KEEL

A movable **hull appendage** primarily used to affect stability, attached approximately on the **hull** centreplane and rotating around a single longitudinal axis.

(d) FIN

A fixed **hull appendage** primarily used to affect leeway or directional control.

(e) BULB

A **hull appendage** containing **ballast** at the bottom of another **hull appendage** primarily used to affect stability.

(f) SKEG

A **fin** attached immediately in front of a **rudder**.

(g) CENTREBOARD

A retractable **hull appendage**, attached approximately on the **hull** centreplane and rotating about a single transverse axis which may move in relation to the **hull**, primarily used to affect leeway.

(h) DAGGERBOARD

A retractable **hull appendage**, attached approximately on the **hull** centreplane and not rotating, primarily used to affect leeway.

(i) BILGEBOARD

A retractable **hull appendage**, attached off the **hull** centreplane, primarily used to affect leeway.

(j) RUDDER

A movable **hull appendage** primarily used to affect steering.

(k) TRIM TAB

When a **rudder(s)** is used, a movable **hull appendage**, attached at the aft, or fore edge of another **hull appendage**.



## Section F – Rig Definitions

### F.1 GENERAL RIG TERMS

#### F.1.1 Rig

The **spars, spreaders, rigging, fittings** and any **corrector weights**.

#### F.1.2 Rig Configurations

(a) UNA RIG

A single-masted **rig** with a **mainsail** only.

(b) SLOOP RIG

A single-masted **rig** with a **mainsail** and one staysail **headsail**.

(c) CUTTER RIG

A single-masted **rig** with more than one staysail **headsail**.

(d) KETCH RIG

A two-masted **rig** with the fore mast – the **mainmast** – taller than the aft mast – the **mizzenmast** – set forward of the rudder stock.

(e) YAWL RIG

A two-masted **rig** with the fore mast – the **mainmast** – taller than the aft mast – the **mizzenmast** – set aft of the rudder stock.

(f) SCHOONER RIG

A two-masted **rig** with the fore mast – the **foremast** – shorter than, or the same height as, the aft mast – the **mainmast**.

#### F.1.3 Spar

The main structural part(s) of the **rig**, to, or from which **sails** are attached and/or supported.

#### F.1.4 Spar Types

(a) MAST

A **spar** on which the **head** or **throat** of a **sail**, or a **yard**, is set. Includes its **standing rigging, running rigging, spreaders, fittings** and any **corrector weights**, but not **running rigging** and fittings that are not essential to the function of the mast as part of the **rig**.

**Mast** Types:

(i) MAINMAST

(a) The only **mast** in a **una rig, sloop rig** or **cutter rig**.

(b) The fore **mast** in a **ketch rig** or **yawl rig**.

(c) The aft **mast** in a **schooner rig**.

(ii) FOREMAST

The fore **mast** in a **schooner rig**.

(iii) MIZZENMAST

The aft **mast** in a **ketch rig** or **yawl rig**.

(b) BOOM

A **spar** attached at one end to a mast **spar** or a **hull** and on which the **clew** of a **sail** is set and on which the **tack** and/or **foot** of the **sail** may be set. Includes its **rigging**, fittings and any **corrector weights**, but not **running rigging**, **running rigging** blocks and/or any kicking strap/strut arrangement.

**Boom Types:**

(i) FOREMAST SAIL BOOM

A **boom** attached to a **foremast spar** to support a **foremast sail**.

(ii) HEADSAIL BOOM

A **boom** attached to a **hull** to support a **headsail clew**.

(iii) MAIN BOOM

A **boom** attached to a **mainmast spar** to support a **mainsail**.

(iv) MIZZEN BOOM

A **boom** attached to a **mizzenmast spar** to support a **mizzen**.

(v) WISHBONE BOOM

A double **boom** attached to a mast **spar** to support a **sail** and which has one **spar** on each side of the **sail**.

(c) HULL SPARS

A spar attached to the hull.

(i) BOWSPRIT

A **hull spar** extending forward to attach **rigging** and/or the **tack** of a **headsail**, or **headsails**.

(ii) BUMPKIN

A **hull spar** extending aft to sheet a **sail** and/or attach **rigging**.

(iii) DECK SPREADER

A **hull spar** extending transversely to attach **standing rigging**.

(d) OTHER SPARS

Other **spar** types include their **rigging**, fittings and any **corrector weights**, but not **running rigging**.

**Other Spar Types:**

(i) SPINNAKER POLE

A **spar** attached to the mast **spar** to set a spinnaker.

(ii) WHISKER POLE

A **spar** attached to the mast **spar** and a **headsail clew**.

(iii) GAFF

A **spar** attached at one end to a mast **spar** to set the peak, throat and/or head of a quadrilateral **sail**.

(iv) SPRIT

A **spar** attached at one end to a mast **spar** or a hull to set only the peak of a quadrilateral **sail**.

(v) YARD

A **spar** hoisted on a mast **spar** at a point between its ends to set the **head** of a quadrilateral sail or the **luff** of a lateen **sail**.

**F.1.5 Spreader**

Equipment used to brace a **spar**, attached at one end to the **spar** and the other end to **rigging** and working in compression when in use.

**F.1.6 Rigging**

Any equipment attached at one or both ends to **spars, sails** or other **rigging** and capable of working in tension only. Includes associated fittings which are not permanently fixed to a **hull, spar** or **spreader**.

**F.1.7 Rigging Types**

(a) STANDING RIGGING

**Rigging** used to support a mast **spar** or **hull spar**. It may be adjustable.

**Standing Rigging** types:

(i) SHROUD

**Rigging** used to provide transverse support for a mast **spar** or **hull spar** and which may also provide longitudinal support and is not detached when racing.

(ii) STAY

**Rigging** mainly used to provide longitudinal support for a mast **spar** or **hull spar** or a **sail**.

(iii) FORESTAY

**Rigging** used to provide forward support for a mast **spar** and is not detached when racing.

(b) RUNNING RIGGING

**Rigging** primarily used to adjust a **spar**, a **sail** or a **hull appendage**.

**Running Rigging** types:

(i) HALYARD

**Rigging** used to hoist a **sail, spar**, flag or a combination thereof.

(ii) BACKSTAY

**Rigging** mainly used to provide aft support for a mast **spar** above the **upper limit mark**.

(iii) RUNNING BACKSTAY

**Rigging** used to provide aft support for a mast **spar** at a point, or points, between the **upper limit mark** and the **forestay rigging point**.

(iv) CHECKSTAY

**Rigging** used to provide aft support for a mast **spar** at a point, or points, between the **lower limit mark** and the **forestay rigging point**.

(v) OUTHAUL

**Rigging** used to trim the **clew** of a **sail** along a boom **spar**.

(vi) SHEET

**Rigging** used to trim the **clew** of a **sail**, or a boom **spar**.

(vii) SPINNAKER GUY

**Rigging** used to trim the **tack** of a spinnaker.

(c) OTHER RIGGING

(i) TRAPEZE

**Rigging** attached to a mast **spar** used to support a single **crew** member.

**F.1.8 Foretriangle**

The area formed by the foreside of the foremost mast **spar**, the foremost **forestay** and the deck including any superstructure.

**F.1.9 Limit Marks**

(a) LIMIT MARK DIMENSIONS

(i) LIMIT MARK WIDTH

The minimum width measured in the length direction of the **spar**.

**F.2 MAST MEASUREMENT DEFINITIONS**

**F.2.1 Mast Measurement Points**

(a) MAST DATUM POINT

The point on the **mast** specified in the **class rules** used as a datum for measurement.

(b) HEEL POINT

The lowest point on the **spar** and its fittings.

(c) TOP POINT

The highest point on the **spar** and its fittings.

(d) LOWER POINT

The highest point of the **lower limit mark** at the aft edge of the **spar**.

(e) UPPER POINT

The lowest point of the **upper limit mark** at the aft edge of the **spar**.

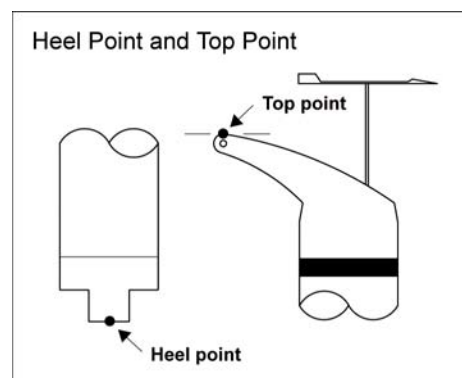

**F.2.2 Mast Limit Marks**

(a) LOWER LIMIT MARK

The **limit mark** for the setting of a boom **spar** or **sail**.

(b) UPPER LIMIT MARK

The limit mark for the setting of a sail.

**F.2.3 Mast Dimensions**

See H.4.

(a) MAST LENGTH

The distance between the **heel point** and the **top point**.

(b) LOWER POINT HEIGHT

The distance between the **mast datum point** and the **lower point**.

(c) UPPER POINT HEIGHT

The distance between the **mast datum point** and the **upper point**.

(d) RIGGING POINT

When **rigging** is attached:

**BY HOOK TERMINAL:** The lowest point of the hook where it intersects the **spar**, extended as necessary.

**BY TANG WITH THROUGH FIXING:** The lowest point of the **spar** through fixing where it intersects the **spar**.

**BY EYE WITH BOLT OR OTHER THROUGH FIXING:** The lowest point of the **spar** bolt, or through fixing, where it intersects the **spar**.

**IN OTHER WAYS:** The intersection of the outside of the **spar**, extended as necessary, and the centreline of the **rigging**.

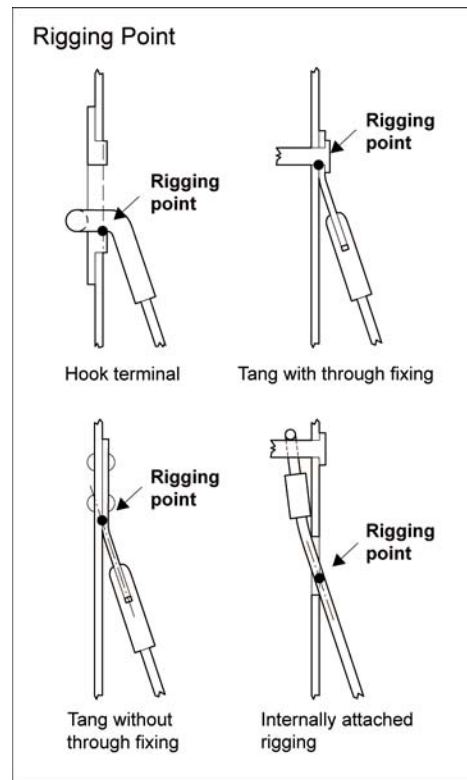

(e) FORESTAY HEIGHT

The distance between the **mast datum point** and the **rigging point**.

(f) SHROUD HEIGHT

The distance between the **mast datum point** and the **rigging point**.

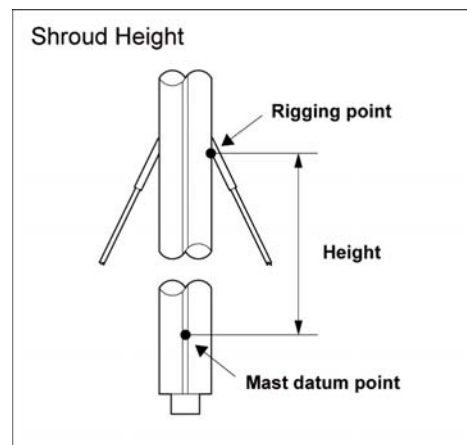
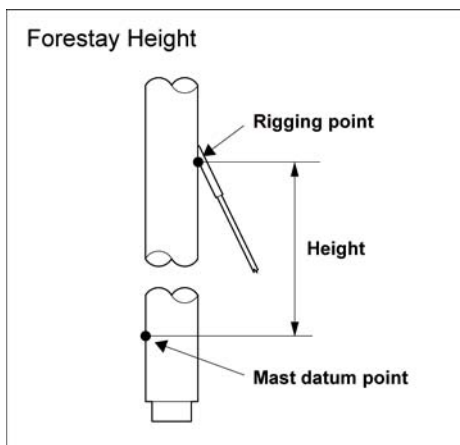

(g) BACKSTAY HEIGHT

The distance between the **mast datum point** and the **rigging point** or the **top point** whichever is the lowest.

(h) CHECKSTAY HEIGHT

The distance between the **mast datum point** and the **rigging point**.

(i) TRAPEZE HEIGHT

The distance between the **mast datum point** and the **rigging point**.

(j) SPINNAKER HOIST HEIGHT

The distance between the **mast datum point** and the intersection of the **spar** and the lower edge of the spinnaker **halyard**, when at 90° to the **spar**, each extended as necessary.

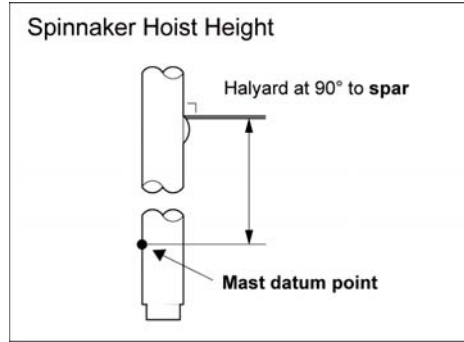

(k) MAST SPAR CURVATURE

The greatest distance between the **spar** and a straight line from the **upper point** to the **lower point** taken at 90° to the straight line when the **spar** is resting on one side.

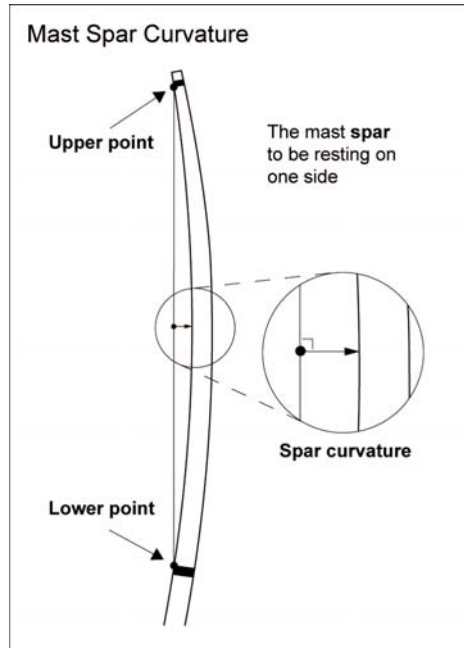

(l) MAST SPAR DEFLECTION

The difference in distance, at a specified distance from the **mast datum point**, between

the **spar** and a straight line from the **upper point** to the **lower point**

taken at 90° to the straight line with and without a specified load at the specified distance when the **spar** is horizontal at and supported at these points.

(i) FORE-AND-AFT: Measured with the aft edge up.

(ii) TRANSVERSE: Measured with one side up.

See H.4.5.

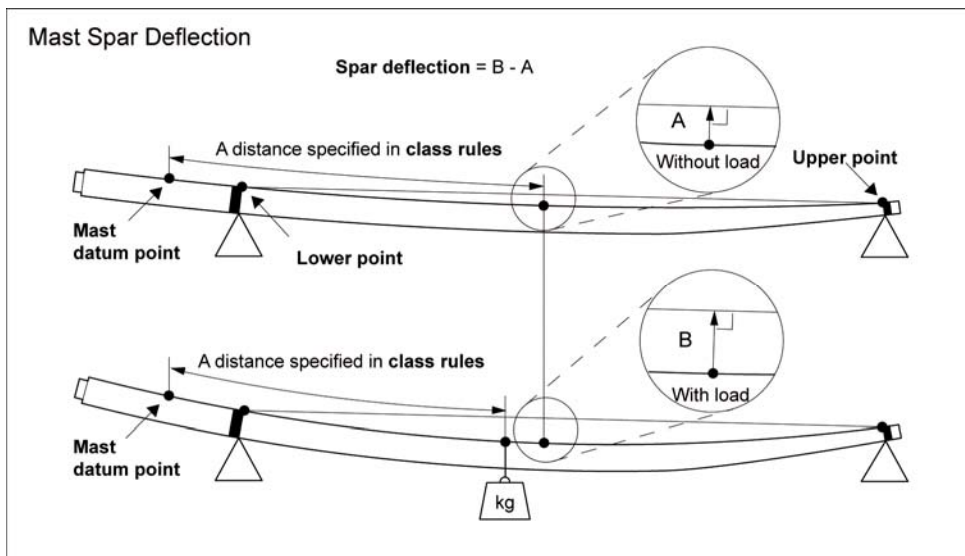

(m) MAST SPAR CROSS SECTION

- (i) FORE-AND-AFT: The fore-and-aft dimension, including any **sail track**, at a specified distance from the **mast datum point**.
- (ii) TRANSVERSE: The transverse dimension, at a specified distance from the **mast datum point**.

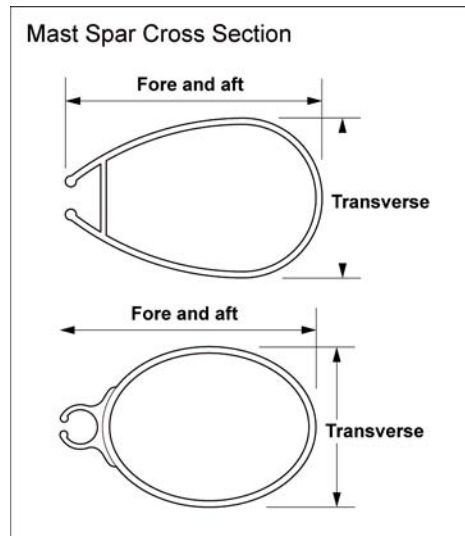

(n) MAST SPAR WEIGHT

The weight of the **spar** including fittings and **corrector weights**.

(o) MAST WEIGHT

The weight of the **mast**.

(p) MAST TIP WEIGHT

The weight of the **mast** measured at the **upper point** when the **spar** is supported at the **lower point**.

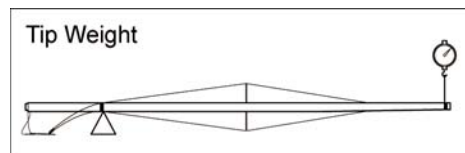

See H.4.6.

(q) MAST CENTRE OF GRAVITY HEIGHT

The distance from the **mast datum point** to centre of gravity of the **mast**.

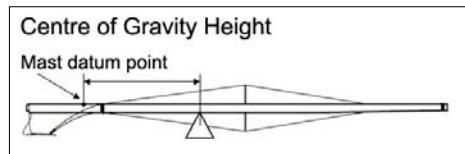

F.2.4 Mast Fittings

(a) SPREADER

- (i) LENGTH: The distance between the inner edge of the **shroud** at the lower edge of the **spreader** and the intersection of the lower edge of the **spreader**, extended as necessary, and the **spar**.
- (ii) HEIGHT: The distance between **mast datum point** and the intersection of the lower edge of the **spreader**, extended as necessary, and the **spar**.

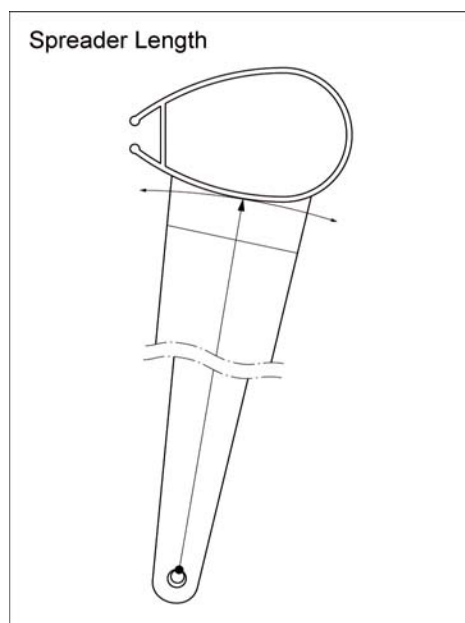
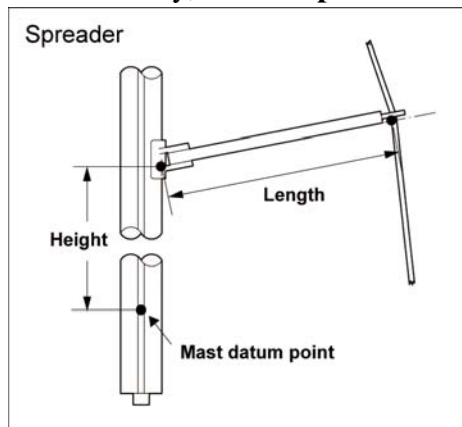

(b) SPINNAKER POLE FITTING

- (i) **HEIGHT**: The distance between the **mast datum point** and the centre of the highest bearing part of the fitting.
- (ii) **PROJECTION**: The shortest distance between the outermost point of the fitting and the **spar**.

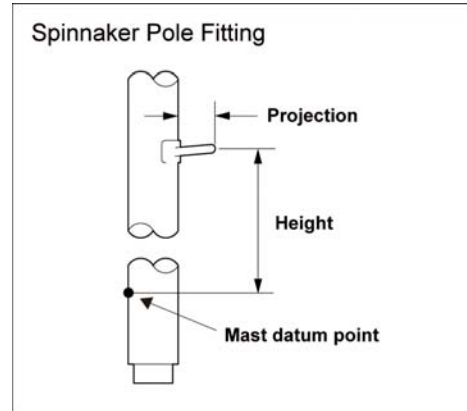

**F.3 BOOM MEASUREMENT DEFINITIONS**

**F.3.1 Boom Measurement Points**

(a) OUTER POINT

The point on the boom **outer limit mark**, at the upper edge of the **spar**, nearest the fore end of the **spar**.

**F.3.2 Boom Limit Marks**

(a) OUTER LIMIT MARK

The **limit mark** for the setting of a **mainsail, foresail or mizzen**.

**F.3.3 Boom Dimensions**

See H.4.

(a) OUTER POINT DISTANCE

The distance between the **outer point** and the aft edge of the mast **spar**, with the boom **spar** on the mast **spar** centreplane and at 90° to the mast **spar**.

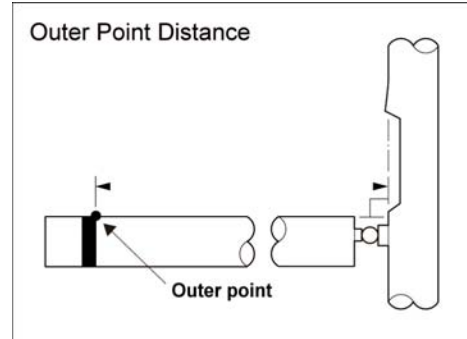

(b) BOOM SPAR CURVATURE

The greatest distance between the **spar** and a straight line from the uppermost fore end of the **spar** to the **outer point** or, where there is no **outer point**, to the uppermost aft end of the **spar**, taken at 90° to the straight line when the spar is resting on one side.

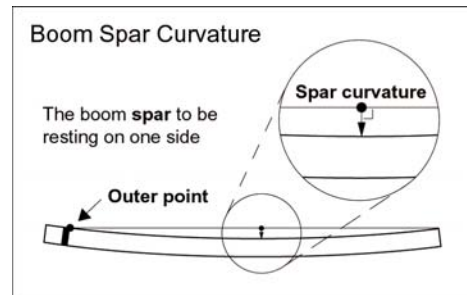



(c) BOOM SPAR DEFLECTION

The difference in distance, at a specified distance from the **outer point**, between

the **spar**

and a straight line from the **outer point** to the top of the fore end of the **spar**

taken at 90° to the straight line and with and without a specified load at the specified distance when the **spar** is horizontal and supported at these points.

(i) VERTICAL: Measured with the top edge up.

(ii) TRANSVERSE: Measured with one side up.

See H.4.5.

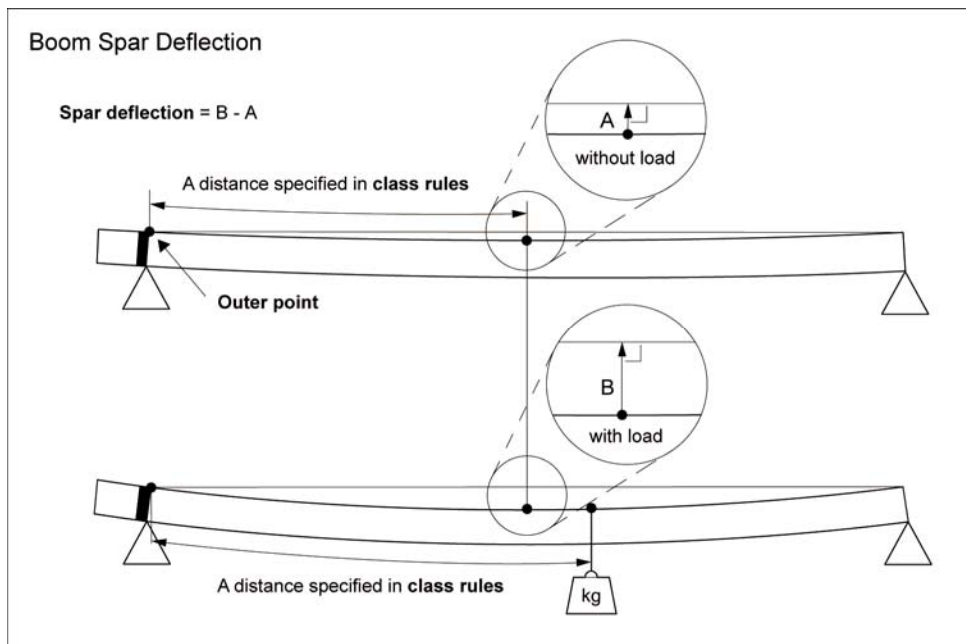

(d) BOOM SPAR CROSS SECTION

(i) VERTICAL: The vertical dimension, including any **sail** track, at a specified distance from the **outer point**.

(ii) TRANSVERSE: The transverse dimension at a specified distance from the **outer point**.

(e) BOOM WEIGHT

The weight of the **boom**.

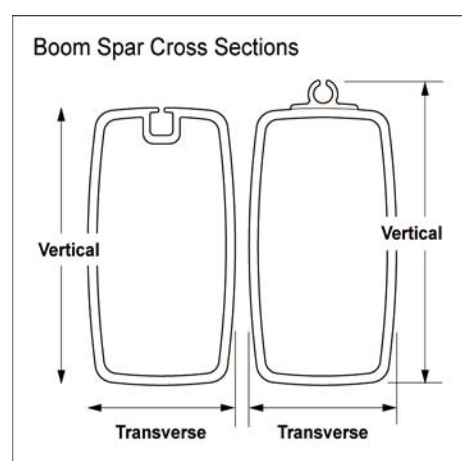

## F.4 SPINNAKER/WHISKER POLE MEASUREMENT DIMENSIONS

See H.4.

- (a) SPINNAKER/WHISKER POLE LENGTH

The distance between the ends of the **spinnaker/whisker pole**.

- (b) SPINNAKER/WHISKER POLE SPAR CROSS SECTION

The sectional dimensions at specified distances from an end of the **spinnaker/whisker pole**.

- (c) SPINNAKER/WHISKER POLE WEIGHT

The weight of the **spinnaker/whisker pole**.

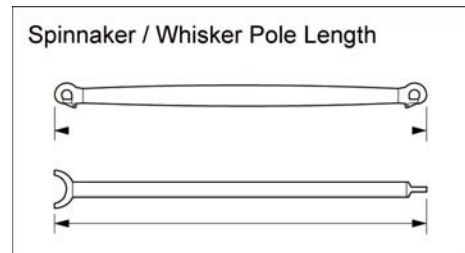

## F.5 BOWSPRIT MEASUREMENT DEFINITIONS

### F.5.1 Bowsprit Measurement Points

- (a) BOWSPRIT INNER POINT

The point of the **bowsprit inner limit mark**, at the upper edge of the **spar**, nearest the outboard end of the **spar**.

- (b) BOWSPRIT OUTER POINT

The point of the **bowsprit outer limit mark**, at the upper edge of the **spar**, nearest the inner end of the **spar**, or the outboard end of the **spar** when there is no **outer limit mark**.

### F.5.2 Bowsprit Limit Marks

- (a) BOWSPRIT INNER LIMIT MARK

The **limit mark** for the setting of the **spar**.

- (b) BOWSPRIT OUTER LIMIT MARK

The **limit mark** for the setting of a **headsail**.

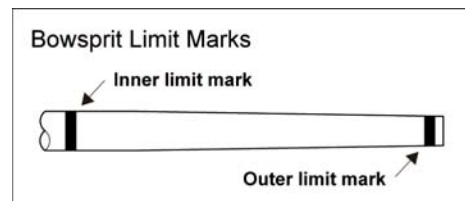

### F.5.3 Bowsprit Dimensions

See H.4.

- (a) BOWSPRIT POINT DISTANCE

The distance between the **bowsprit inner point** and the **bowsprit outer point**.

- (b) BOWSPRIT SPAR CROSS SECTION

The sectional dimensions at specified positions.

- (c) BOWSPRIT WEIGHT

The weight of the **bowsprit**.

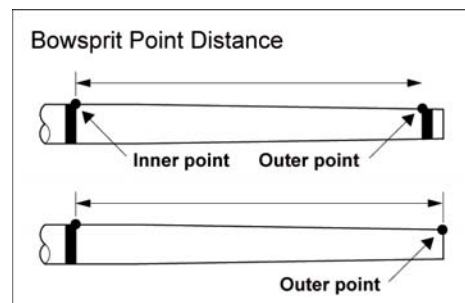

## F.6 FORETRIANGLE MEASUREMENT DEFINITIONS

### F.6.1 Foretriangle Dimensions

(a) FORETRIANGLE BASE

The longitudinal distance between the intersection of the fore side of the mast **spar**, extended as necessary, and the deck including any superstructure, and the intersection of the centreline of the **forestay**, extended as necessary, and the deck, or bowsprit **spar**.

See H.3.4.

(b) FORETRIANGLE HEIGHT

The distance between the intersection of fore side of the mast **spar**, extended as necessary, and the deck including any superstructure, and the **forestay rigging point**.

See H.4.

(c) FORETRIANGLE AREA

Half the product of the **foretriangle base** and the **foretriangle height**.

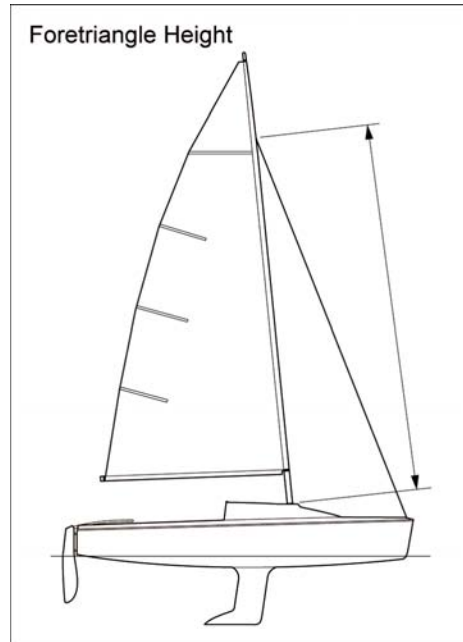
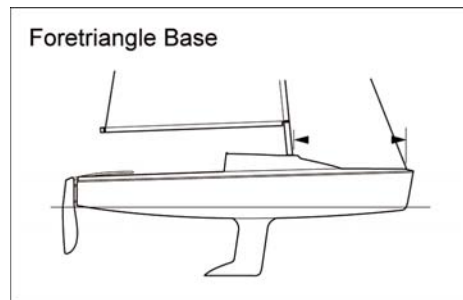

## Section G – Sail Definitions

### Subsection A – Trilateral Sails

Definitions relating to **sails** with only three **sail edges**:

“MAINSAIL” also applies to **foremast sail** and **mizzen**.

“HEADSAIL” also applies to “jib” and “genoa”.

“SPINNAKER” also applies to “gennaker”.

### G.1 GENERAL SAIL TERMS

#### G.1.1 Sail

An item of equipment, used to propel the **boat**. It includes any of the following added parts:

**sail reinforcements**

**batten pockets**

**windows**

**stiffening**

**tabling**

**sail edge** ropes and wires

**attachments**

other parts as permitted by **class rules**.

#### G.1.2 Set Flying

A **sail** set with no **sail edge** attached to the **rig**.

#### G.1.3 Sail Types

(a) MAINSAIL

A **sail** with the **luff** attached to the **mainmast spar**. The lowest of the **sails** if more than one **sail** with the **luff** set to that **spar**.

(b) FOREMAST SAIL

A **sail** with the **luff** attached to the **foremast spar**. The lowest of the **sails** if more than one **sail** with the **luff** set to that **spar**.

(c) MIZZEN

A **sail** with the **luff** attached to the **mizzenmast spar**. The lowest of the **sails** if more than one **sail** with the **luff** set to that **spar**.

(d) HEADSAIL

A **sail** set forward of the mast **spar**, or of the foremost mast **spar** if more than one mast.

**G.1.4 Sail Construction**

(a) **BODY OF THE SAIL**

The **sail** excluding the areas where parts are added as per G.1.1.

(b) **PLY**

A sheet of sail material which may be made up of a number of layers.

(c) **SOFT SAIL**

A **sail** where the **body of the sail** is capable of being folded flat in any direction without damaging any **ply** other than by creasing.

(d) **WOVEN PLY**

A **ply** which, when torn, can be separated into fibres without leaving evidence of a film.

(e) **LAMINATED PLY**

A **ply** made up of more than one layer.

(f) **SINGLE-PLY SAIL**

A **sail**, except at **seams**, where all parts of the **body of the sail** consist of only one **ply**.

(g) **DOUBLE LUFF SAIL**

A **sail** with more than one **luff**, or a **sail** passing around a **spar** and attached back on itself.

(h) **SEAM**

Overlap where two or more **ply** forming the **body of the sail** are joined.

(i) **DART**

An overlap formed at a **sail edge** by overlapping the **ply** edges of a cut in the **body of the sail**.

(j) **TUCK**

Overlap where a **ply** is folded and joined.

(k) **BATTEN POCKET**

Additional **ply** to form a pocket for a batten.

(l) **SAIL OPENING**

Any opening other than openings created by **attachments** or **batten pockets**.

(m) **WINDOW**

A predominantly transparent **ply** in the **body of the sail**.

(n) **STIFFENING**

Corner boards and battens.

(o) ATTACHMENTS

cringles  
straps  
hanks  
slides  
adjustment eyes  
adjustment points  
reefing eyes  
reefing points, and  
blocks and their fastenings.

See H.5.3.

(p) SAIL EDGE SHAPE

The shape of a **sail edge** as a comparison with a straight line between **corner points** or,  
in the case of a **leech** other than of a gennaker or spinnaker, between the **clew point** and the **aft head point**.

## G.2 SAIL EDGES

### G.2.1 Foot

The bottom edge.

### G.2.2 Leech

The aft edge.

### G.2.3 Luff

The fore edge.

### G.2.4 Sail Leech Hollow

Concavity in the shape of a **leech** between adjacent **batten pockets**, or a **batten pocket** and the adjacent **corner point**, or in the case of a **mainsail**, **foremast sail**, **mizzen** or a **headsail** other than a spinnaker or a gennaker, between the **aft head point** and the adjacent **batten pocket**.

## G.3 SAIL CORNERS

### G.3.1 Clew

The region where the **foot** and the **leech** meet.

### G.3.2 Head

The region at the top.

### G.3.3 Tack

The region where the **luff** and the **foot** meet.

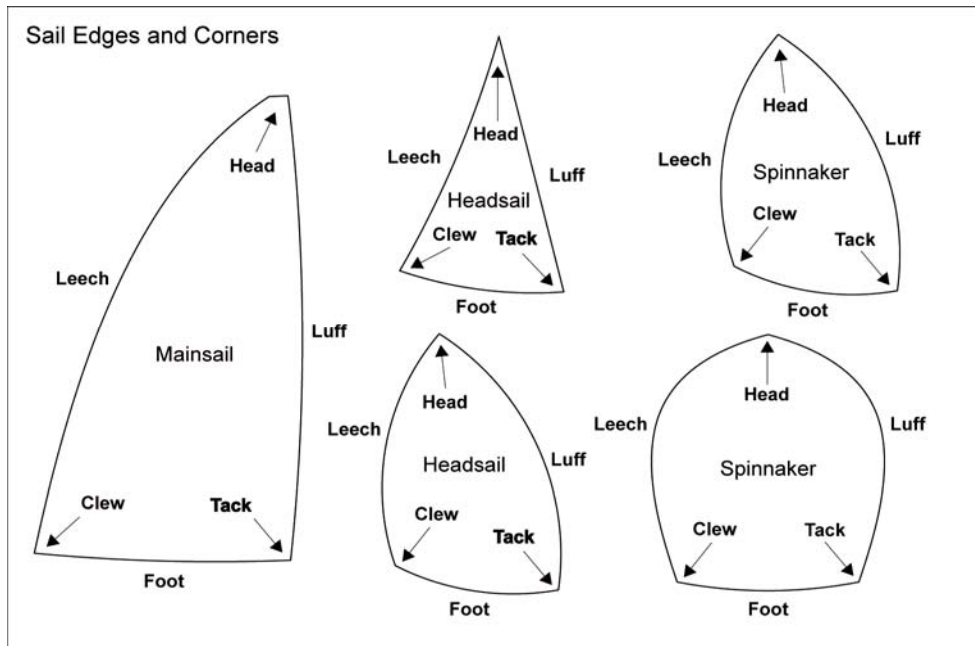

## G.4 SAIL CORNER MEASUREMENT POINTS

### G.4.1 Clew Point

The intersection of the **foot** and the **leech**, each extended as necessary.

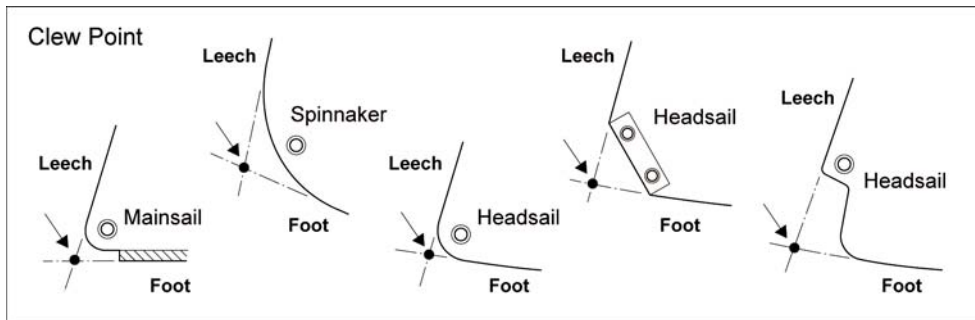

### G.4.2 Head Point

- MAINSAIL:** The intersection of the **luff**, extended as necessary, and the line through the highest point of the **sail** at 90° to the **luff**.
- HEADSAIL:** The intersection of the **luff**, extended as necessary, and the line through the highest point of the **sail**, excluding **attachments**, at 90° to the **luff**.
- SPINNAKER:** The intersection of the **luff** and the **leech**, extended as necessary.

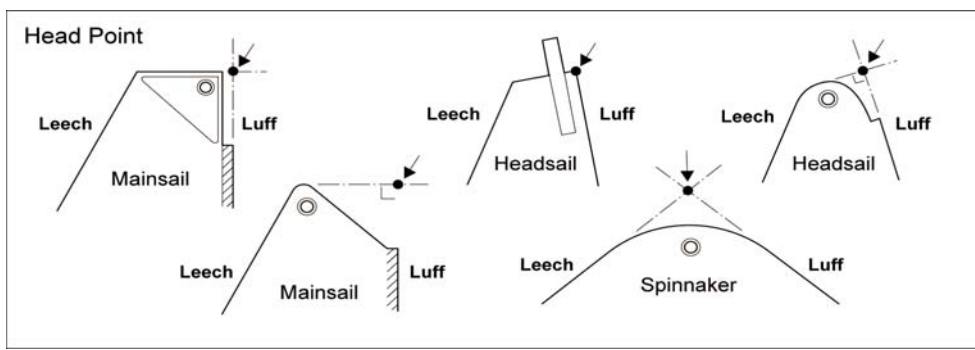

**G.4.3 Tack Point**

The intersection of the **foot** and the **luff**, each extended as necessary.

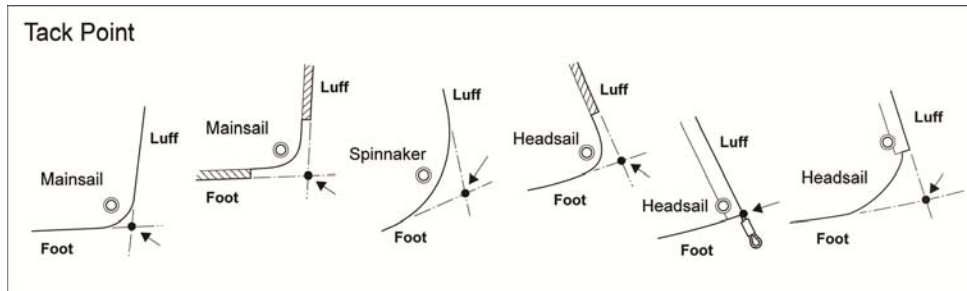

**G.5 OTHER SAIL MEASUREMENT POINTS**

**G.5.1 Quarter Leech Point**

The point on the **leech** equidistant from the **half leech point** and the **clew point**.

**G.5.2 Half Leech Point**

The point on the **leech** equidistant from the **head point** and the **clew point**.

**G.5.3 Three-Quarter Leech Point**

The point on the **leech** equidistant from the **head point** and the **half leech point**.

**G.5.4 Upper Leech Point**

The point on the **leech** a specified distance from the **head point**.

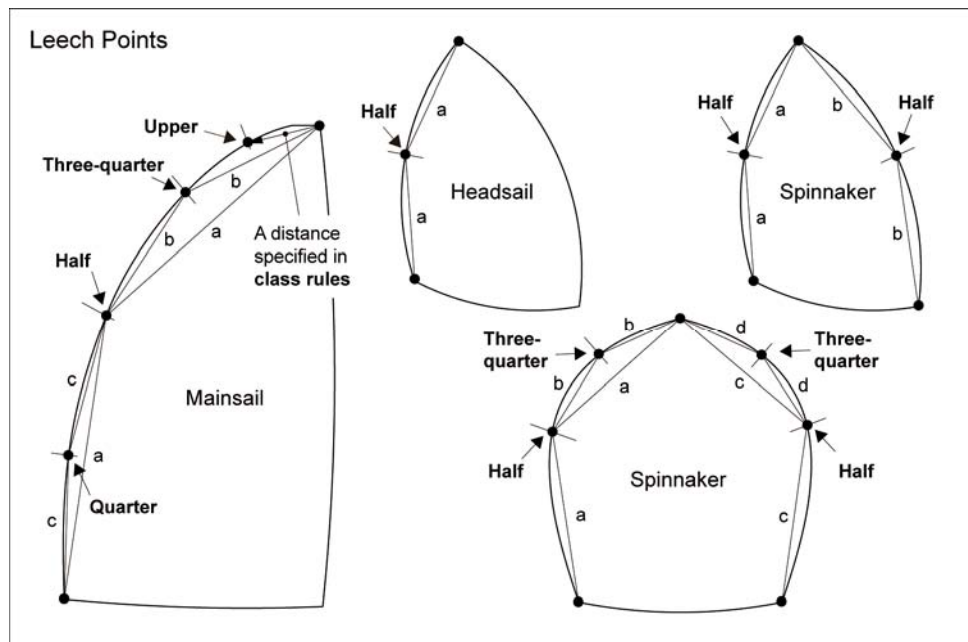



**G.5.5 Aft Head Point**

**MAINSAIL** and **HEADSAIL**: The intersection of the **leech** extended as necessary and the line through the **head point** at 90° to the **luff**.

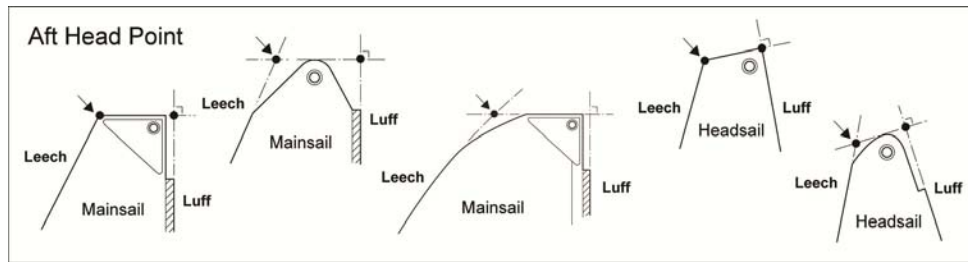

**G.5.6 Quarter Luff Point**

The point on the **luff** equidistant from the **half luff point** and the **tack point**.

**G.5.7 Half Luff Point**

The point on the **luff** equidistant from the **head point** and the **tack point**.

**G.5.8 Three-Quarter Luff Point**

The point on the **luff** equidistant from the **head point** and the **half luff point**.

**G.5.9 Upper Luff Point**

The point on the **luff** a specified distance from the **head point**.

**G.5.10 Mid Foot Point**

The point on the **foot** equidistant from the **tack point** and the **clew point**.

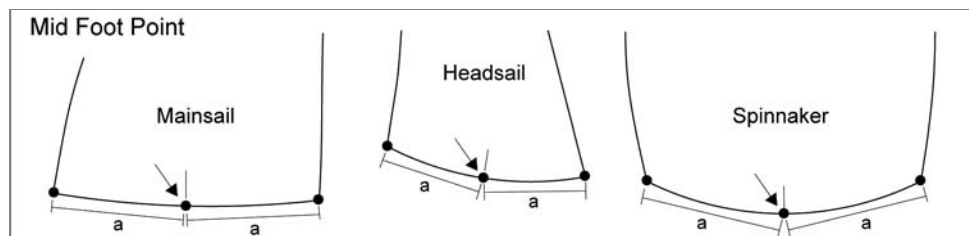

**G.6 SAIL REINFORCEMENT**

**G.6.1 Primary Reinforcement**

An unrestricted number of additional layers of **ply** of permitted material:

- at a corner
- at a adjustment point
- at a reefing point adjacent to the **luff**
- at a reefing point adjacent to the **leech**
- at a **sail** recovery point
- where permitted by the **class rules**

### G.6.2 Secondary Reinforcement

Not more than two additional layers of **ply** of permitted material each not thicker than the maximum thickness of the **ply** of the **body of the sail**:

- at a corner
- at an adjustment point
- at a reefing point adjacent to the **luff**
- at a reefing point adjacent to the **leech**
- at a **sail** recovery point
- to form a **flutter patch**
- to form a **chafing patch**
- to form a **batten pocket patch**
- where permitted by the **class rules**

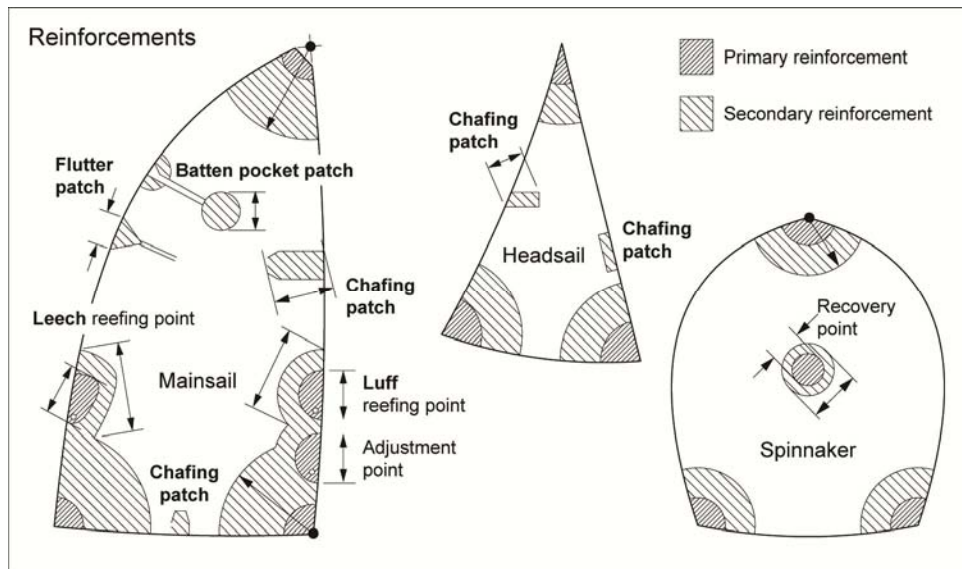

### G.6.3 Tabling

Additional **ply** and/or folded **ply** overlap(s) at a **sail edge**.

### G.6.4 Batten Pocket Patch

**Secondary reinforcement** at an end of a **batten pocket**.

### G.6.5 Chafing Patch

**Secondary reinforcement** where a **sail** can touch a **spreader**, stanchion, **shroud** or **spinnaker pole**.

### G.6.6 Flutter Patch

**Secondary reinforcement** on the **leech** or the **foot** at the end of a **seam**.

## G.7 PRIMARY SAIL DIMENSIONS

See H.5.

### G.7.1 Foot Length

The distance between the **clew point** and the **tack point**.

### G.7.2 Leech Length

The distance between the **head point** and the **clew point**.

### G.7.3 Luff Length

The distance between the **head point** and the **tack point**.

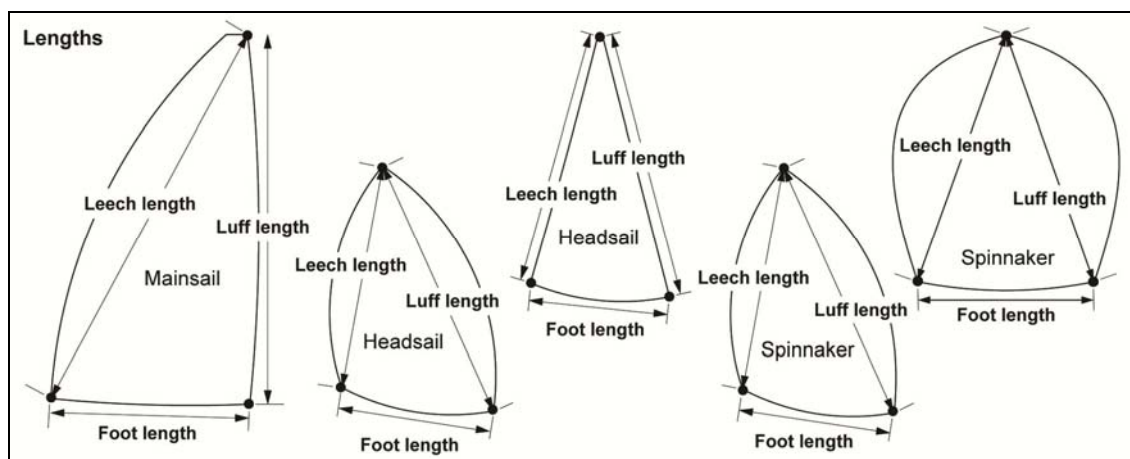

### G.7.4 Quarter Width

- (a) MAINSAIL and HEADSAIL: The shortest distance between the **quarter leech point** and the **luff**.
- (b) SPINNAKER: The distance between the **quarter luff point** and the **quarter leech point**.

### G.7.5 Half Width

- (a) MAINSAIL and HEADSAIL: The shortest distance between the **half leech point** and the **luff**.
- (b) SPINNAKER: The distance between the **half luff point** and the **half leech point**.

### G.7.6 Three-Quarter Width

- (a) MAINSAIL and HEADSAIL: The shortest distance between the **three-quarter leech point** and the **luff**.
- (b) SPINNAKER: The distance between the **three-quarter luff point** and **three-quarter leech point**.

### G.7.7 Upper Width

- (a) MAINSAIL and HEADSAIL: The shortest distance between the **upper leech point** and the **luff**.
- (b) SPINNAKER: The distance between the **upper luff point** and the **upper leech point**.

**G.7.8 Top Width**

- (a) MAINSAIL and HEADSAIL: The distance between the **head point** and the **aft head point**.

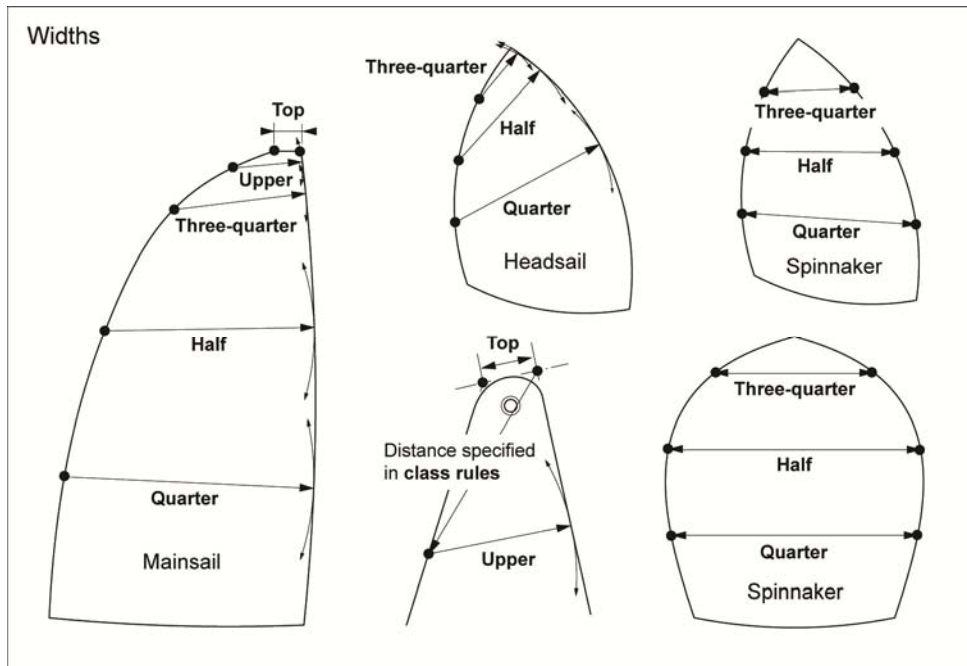

**G.7.9 Diagonals**

- (a) CLEW DIAGONAL: The distance between the **clew point** and the **half luff point**.
- (b) TACK DIAGONAL: The distance between the **tack point** and the **half leech point**.

**G.7.10 Foot Median**

The distance between the **head point** and the **mid foot point**.

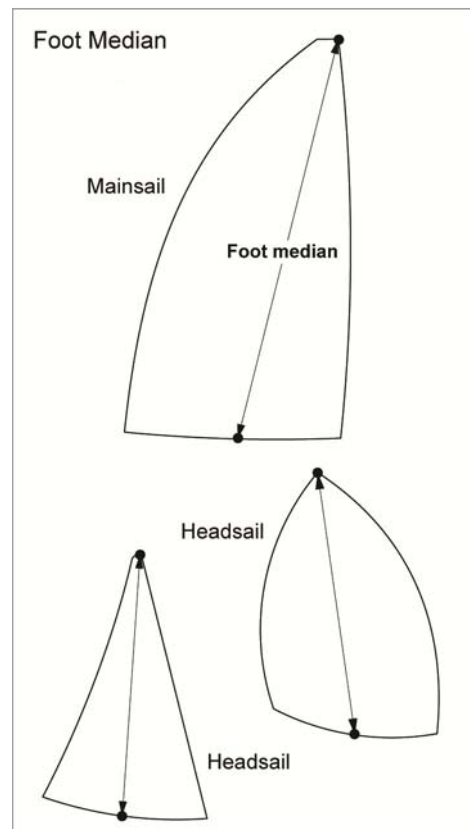
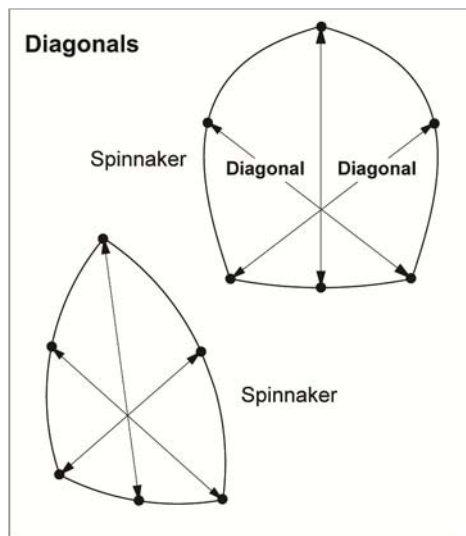

**G.7.11 Luff Perpendicular**

The shortest distance between the **clew point** and the **luff**.

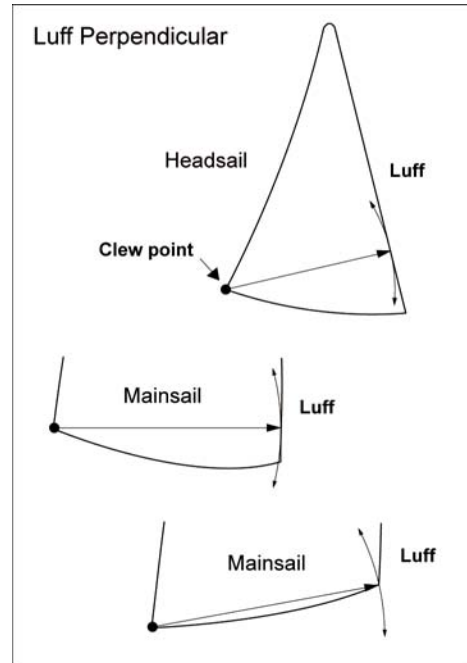

**G.8 OTHER SAIL DIMENSIONS**

See H.5.

**G.8.1 Batten Pocket Length**

(a) **INSIDE:** The greatest distance between the **sail edge** and the internal extreme end of the **batten pocket**, measured parallel to the pocket centreline. The effect of any elastic or other retaining device and any local widening for batten insertion shall be ignored.

(b) **OUTSIDE:** The greatest distance between the **sail edge** and the external extreme end of the **batten pocket**, measured parallel to the pocket centreline. The effect of any local widening for batten insertion shall be ignored.

**G.8.2 Batten Pocket Width**

(a) **INSIDE:** The greatest distance between inside edges of the **batten pocket** measured at 90° to pocket centreline. Local widening for batten insertion shall be ignored.

(b) **OUTSIDE:** The greatest distance between the outside edges of the **batten pocket** measured at 90° to the pocket centreline. Local widening for batten insertion shall be ignored.

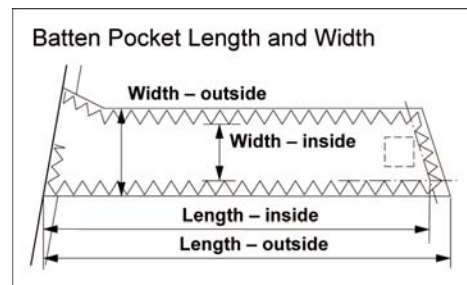

**G.8.3 Foot Irregularity**

The maximum distance between the edges of the **foot** when first the **tack point** and then the **clew point** are superimposed on any part of the **foot**.

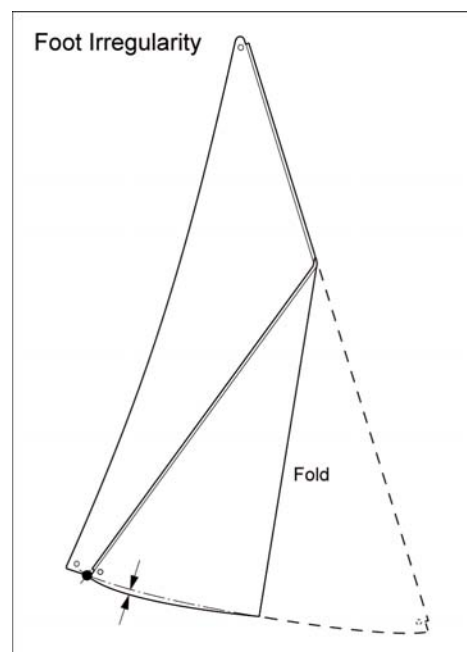

**G.8.4 Reinforcement Size**

(a) **AT A CORNER:** The greatest distance measured from the **sail corner measurement point**.

(b) **TABLING WIDTH:** The width of **tabling** measured at 90° to the **sail edge**.

(c) **ELSEWHERE:** The greatest dimension of the **sail reinforcement**.

**G.8.5 Seam Width**

The width of a **seam** measured at 90° to the **seam**.

**G.8.6 Dart Width**

The width of a **dart** measured at 90° to the **dart** centreline.

**G.8.7 Tuck Width**

The width of a **tuck** measured at 90° to the **tuck** centreline.

**G.8.8 Attachment Size**

(a) AT A CORNER OR AN EDGE

(i) LENGTH

AT THE HEAD: The dimension from the **head point** along the **luff** or its extension to a line through the highest point of the **attachment** at 90° to the **luff**.

AT THE TACK: The dimension from the **tack point** along the **luff** or its extension to a line through the lowest point of the **attachment** at 90° to the **luff**.

AT THE CLEW: The greatest dimension from the **clew point**.

AT AN EDGE: The greatest dimension from the **sail edge**.

(ii) WIDTH

The greatest dimension measured perpendicular to the length.

(b) ELSEWHERE

The greatest dimension of the **attachment**.

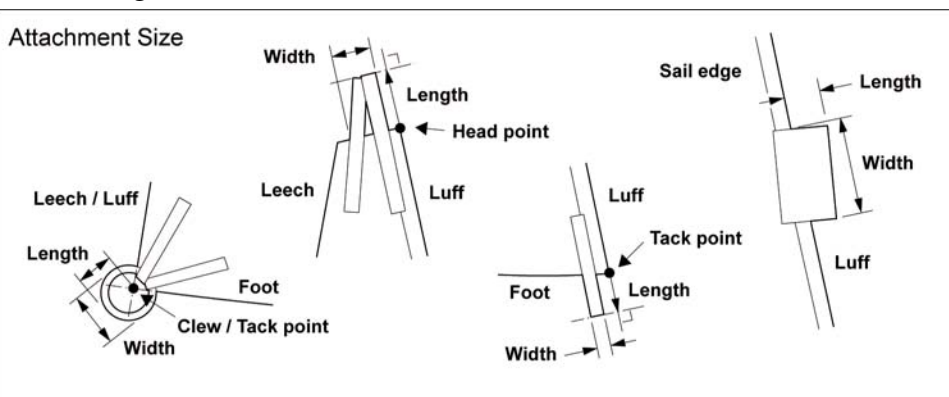
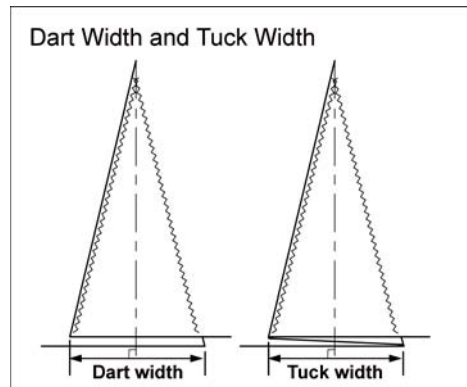
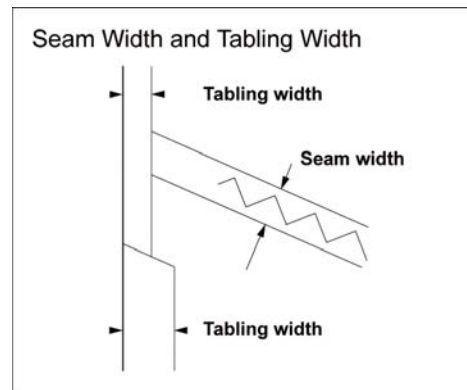

**G.8.9 Window Ply Area**

The area of the **window ply**.

**G.8.10 Window Area**

The **window ply area** excluding **seams**.

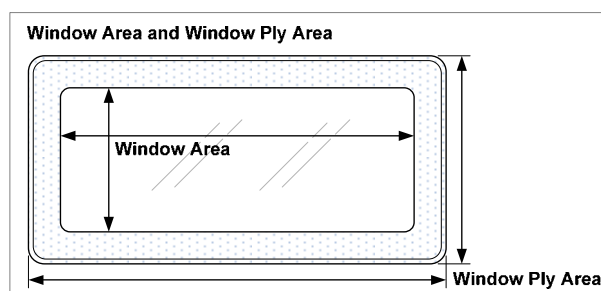

## Subsection B – Additions for Other Sails

The following definitions for non-trilateral sails are additional to or vary those given in Subsection A of this Section.

### G.2 SAIL EDGES

#### G.2.5 Head

The top edge.

### G.3 SAIL CORNERS

#### G.3.4 Peak

The region where the **head** and the **leech** meet.

#### G.3.5 Throat

The region where the **head** and the **luff** meet.

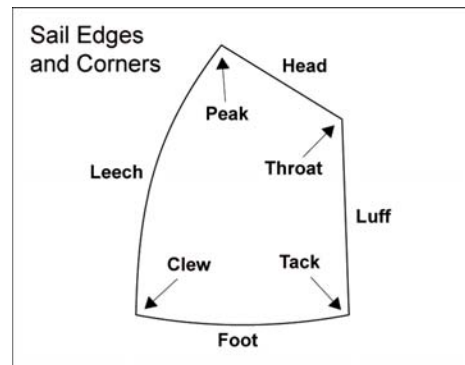

### G.4 SAIL CORNER MEASUREMENT POINTS

#### G.4.4 Peak Point

The intersection of the **head** and **leech**, each extended as necessary.

#### G.4.5 Throat Point

The intersection of the **head** and **luff**, each extended as necessary.

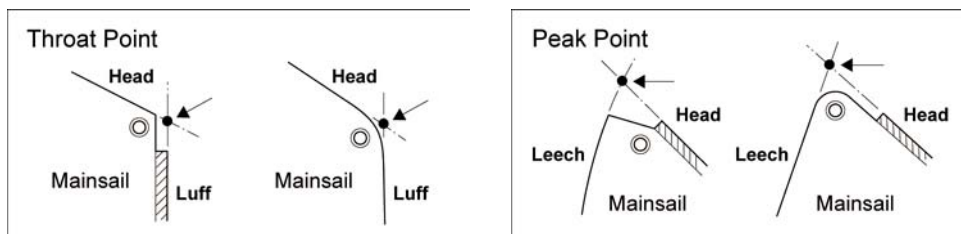

### G.5 OTHER SAIL MEASUREMENT POINTS

#### G.5.2 Half Leech Point

The point on the **leech** equidistant from the **peak point** and the **clew point**.

#### G.5.3 Three-Quarter Leech Point

The point on the **leech** equidistant from the **peak point** and the **half leech point**.

#### G.5.4 Upper Leech Point

The point on the **leech** a specified distance from the **peak point**.



## G.7 PRIMARY SAIL DIMENSIONS

See H.5.

### G.7.2 Leech Length

The distance between the **peak point** and the **clew point**.

### G.7.3 Luff Length

The distance between the **throat point** and the **tack point**.

### G.7.9 Diagonals

(a) CLEW DIAGONAL

The distance between the throat point and the clew point.

### G.7.10 Foot Median

The distance between the **peak point** and the **mid foot point**.

### G.7.12 Head Length

The distance between the **peak point** and the **throat point**.

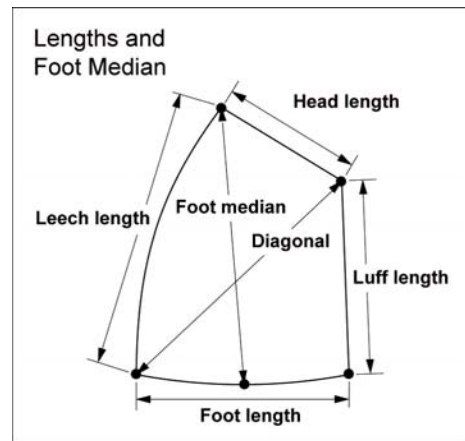



# PART 3 – RULES GOVERNING EQUIPMENT CONTROL AND INSPECTION

---

## Section H – Equipment Control and Inspection

### H.1 CERTIFICATION CONTROL

- H.1.1** An **official measurer** shall not carry out **certification control** of any part of a **boat** owned, designed or built by himself, or in which he is an interested party, or has a vested interest, except where permitted by the MNA or ISAF for In-House Certification.
- H.1.2** If an **official measurer** is in any doubt as to the application of, or compliance with, the **class rules** he shall consult the **certification authority** before signing a certification control form or applying a **certification mark**.
- H.1.3** An **official measurer** shall only carry out **certification control** in another country with the prior agreement of the MNA for that country.

### H.2 EQUIPMENT INSPECTION

- H.2.1** If an **equipment inspector** is in any doubt as to the application of, or compliance with, the **class rules**, the question should be referred to the authority responsible for interpreting the **class rules**.

### H.3 MEASUREMENT AXES

- H.3.1** For a **boat**, unless otherwise specified, words such as “fore”, “aft”, “above”, “below”, “height”, “depth”, “length”, “beam”, “freeboard”, “inboard” and “outboard” shall be taken to refer to the **boat** in **measurement trim**. All measurements denoted by these, or similar words, shall be taken parallel to one of the three **major axes**.
- H.3.2** For a component, unless otherwise specified, width, thickness, length etc. shall be measured as appropriate for that component, if relevant without reference to the **major axes**.
- H.3.3** Unless otherwise specified, measurements shall be the shortest distance between the measurement points.
- H.3.4** Unless otherwise specified, longitudinal measurements shall be taken parallel to the longitudinal **major axis**.

## H.4 RIG MEASUREMENT

**H.4.1** Measurements in the length direction shall be taken along the **spar** at the side relevant for the measurement and between sectional planes through the measurement points at 90° to the **spar** at each point.

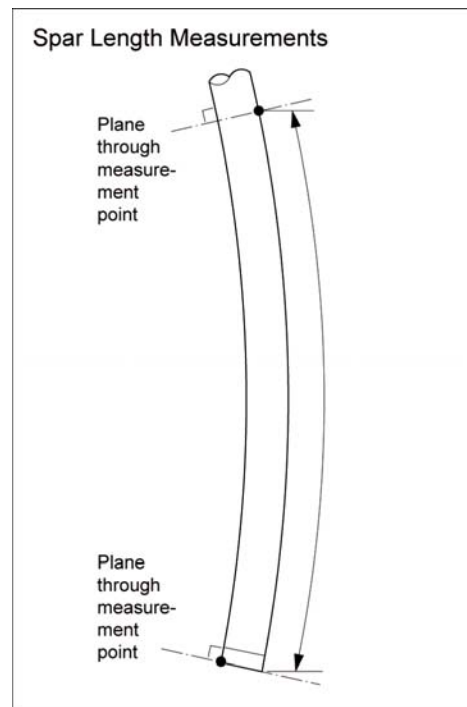
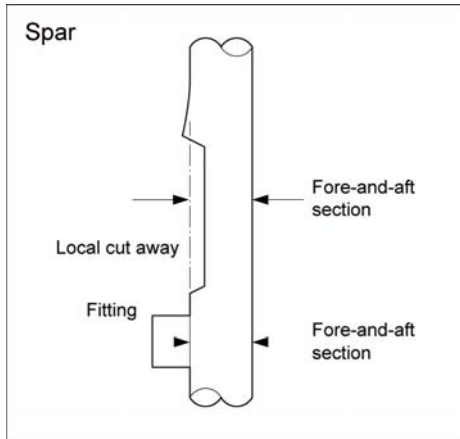

**H.4.2** Fittings, local curvature and local cut away, shall be ignored when measuring a **spar** or dimensions taken to a **spar**.

**H.4.3** No external pressure shall be applied to a **spar** when measuring unless specifically prescribed.

**H.4.4** Adjustable fittings shall be set in the position that gives the greatest value when the measurement is taken.

**H.4.5** **Mast spar deflection** and **boom spar deflection** shall be checked with free ends of **rigging** not supported by the **spar**.

**H.4.6** **Mast tip weight** shall be checked with any **halyards** fully hoisted and **rigging** tied to the **spar** at the **lower limit mark** with lower ends hanging free or resting on the ground.

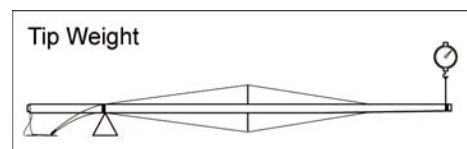

**H.4.7** **Mast centre of gravity height** shall be checked with any **halyards** fully hoisted and **rigging** pulled taut and tied to the **spar** as close to the **lower point** as possible.

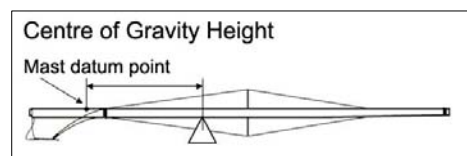

## H.5 SAIL MEASUREMENT

### H.5.1 Condition of the Sail

For measurement the **sail** shall:

- (a) be dry,
- (b) not be attached to **spars** or **rigging**,
- (c) unless the **class rules** prescribe otherwise, have all battens removed,
- (d) have pockets of any type flattened out,
- (e) have just sufficient tension applied to remove wrinkles across the line of the measurement being taken,
- (f) have only one measurement taken at a time and
- (g) be weighed with all **attachments**.

### H.5.2 Hollows in Sail Leeches

Where there is a **sail leech hollow** and a measurement point falls in the hollow:

between adjacent **batten pockets**

between the **aft head point** and adjacent **batten pocket**

between the **clew point** and adjacent **batten pocket**

at an **attachment**.

the **sail** shall be flattened out in the area of the **sail edge**, the **sail edge hollow** shall be bridged by a straight line and the shortest distance from the measurement point to the straight line shall be measured. This distance shall be added to the measurement being taken.

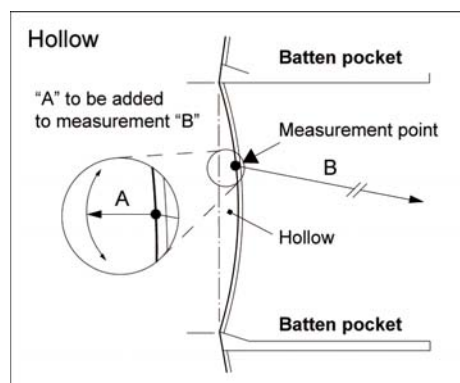

### H.5.3 Excluding Attachments

**Attachments** at a **sail edge**, other than a bolt rope and **tabling**, shall be excluded when measuring.

## H.6 CHECKING MATERIALS

Unless specifically prescribed by the **class rules**, materials are not subject to **certification control**.

## H.7 WEIGHT MEASUREMENT

### H.7.1 Conditions for Weight Measurement

The **boat** shall:

- be dry.
- be in compliance with the **class rules**.

# APPENDIX 1

---

Racing rules that govern the use of equipment:

- 1 Safety
- 40 Personal Flotation Devices
- 42 Propulsion
- 43 Competitor Clothing and Equipment
- 45 Hauling Out; Making Fast; Anchoring
- 47 Limitations on Equipment and Crew
- 48 Fog Signals and Lights; Traffic Separation Schemes
- 49 Crew Position; Lifelines
- 50 Setting and Sheeting Sails
- 51 Movable Ballast
- 52 Manual Power
- 53 Skin Friction
- 54 Forestays and Headsail Tacks
- 77 Identification on Sails
- 78 Compliance with Class Rules; Certificates
- 80 Advertising

It should be noted that racing rule 86.1 permits some of these racing rules to be changed.

The ISAF Advertising Code (ISAF Regulation 20) and Appendices G and H of the racing rules are made applicable by racing rules 80, 77 and 43 respectively. That code and those appendices contain rules governing the use of equipment.

# INDEX OF DEFINITIONS

Defined Term	Rule	Page	Defined Term	Rule	Page
<b>A</b>			Bumpkin	F.1.4(c)(ii)	17
Aft Head Point	G.5.5	32	<b>C</b>		
Attachment Size	G.8.8	37	Canting Keel	E.1.2(c)	14
Attachments	G.1.4(o)	29	Centreboard	E.1.2(g)	14
<b>B</b>			Certificate	C.3.3	9
Backstay	F.1.6(b)(ii)	18	Certification	C.3.1	8
Backstay Height	F.2.3(g)	20	Authority		
Ballast	C.6.3(e)	11	Certification Mark	C.3.4	9
Batten Pocket	G.1.4(k)	28	Certification	C.4.2	9
Batten Pocket Length	G.8.1	36	Measurement		
Batten Pocket Patch	G.6.4	33	Certify/Certification	C.3.2	8
Batten Pocket Width	G.8.2	36	Chafing Patch	G.6.5	34
Bilge Keel	E.1.2(b)	14	Checkstay	F.1.7(b)(iv)	18
Bilgeboard	E.1.2(i)	15	Checkstay Height	F.2.3(h)	20
Boat	C.6.1	10	Class Authority	C.1.1	8
Boat Beam	C.6.4(b)	12	Class Rules	C.2.1	8
Boat Length	C.6.4(a)	11	Class Rules Authority	C.2.4	8
Boat Weight	C.6.4(h)	12	Clew	G.3.1	29
Body of the Sail	G.1.4(a)	28	Clew Diagonal	G.7.9(a)	35
Boom	F.1.4(b)	17	(trilateral sails)		
Boom Spar Cross	F.3.3(d)	24	Clew Diagonal (other	G.7.9(a) * <sup>1</sup>	39
Section			sails)		
Boom Spar Curvature	F.3.3(b)	23	Clew Point	G.4.1	30
Boom Spar Deflection	F.3.3(c)	24	Closed Class Rules	C.2.2	8
Boom Weight	F.3.3(e)	24	Corrector Weight	C.6.3(e)(v)	11
Bowsprit	F.1.4(c)(i)	17	Crew	C.5.1	10
Bowsprit Inner Limit	F.5.2(a)	25	Cutter Rig	F.1.2(c)	16
Mark			<b>D</b>		
Bowsprit Inner Point	F.5.1(a)	25	Daggerboard	E.1.2(h)	14
Bowsprit Outer Limit	F.5.2(b)	25	Dart	G.1.4(i)	28
Mark			Dart Width	G.8.6	37
Bowsprit Outer Point	F.5.1(b)	25	Diagonals (trilateral	G.7.9	35
Bowsprit Point	F.5.3(a)	25	sails)		
Distance			Double Luff Sail	G.1.4(g)	28
Bowsprit Spar Cross	F.5.3(b)	25	Draft	C.6.4(e)	12
Section			<b>E</b>		
Bowsprit Weight	F.5.3(c)	25	Event Limitation	C.4.8	9
Bulb	E.1.2(e)	14	Mark		

## INDEX OF DEFINITIONS

Defined Term	Rule	Page	Defined Term	Rule	Page
External Ballast	C.6.3(e)(ii)	11	Hull	D.1.1	13
Equipment Inspection	C.4.3	9	Hull Appendage	E.1.1	14
Equipment Inspector	C.4.6	9	Hull Beam	D.3.2	13
<b>F</b>			Hull Datum Point	D.2.1	13
Fin	E.1.2(d)	14	Hull Length	D.3.1	13
Flutter Patch	G.6.6	33	Hull Spars	F.1.4(c)	17
Foot	G.2.1	29	Hull Weight	D.4.1	13
Foot Irregularity	G.8.3	36	<b>I</b>		
Foot Length	G.7.1	34	In-house Official	C.4.5	9
Foot Median (trilateral sails)	G.7.10	35	Measurer		
Foot Median (other sails)	G.7.10 * <sup>1</sup>	39	Internal Ballast	C.6.3(e)(i)	11
Foremast	F.1.4(a)(ii)	16	<b>K</b>		
Foremast Sail	G.1.3(b)	27	Keel	E.1.2(a)	14
Foremast Sail Boom	F.1.4(b)(i)	17	Ketch Rig	F.1.2(d)	16
Forestay	F.1.7(a)(iii)	18	Kite-Board	C.6.2(d)	10
Forestay Height	F.2.3(e)	20	<b>L</b>		
Foretriangle	F.1.8	19	Laminated Ply	G.1.4(e)	28
Foretriangle Area	F.6.1(c)	26	Leech	G.2.2	29
Foretriangle Base	F.6.1(a)	26	Leech Length	G.7.2	34
Foretriangle Height	F.6.1(b)	26	(trilateral sails)		
Fundamental Measurement	C.4.1	9	Leech Length (other sails)	G.7.2 * <sup>1</sup>	39
<b>G</b>			Limit Mark	C.4.7	9
Gaff	F.1.4(d)(iii)	17	Limit Mark Width	F.1.9(a)(i)	19
<b>H</b>			Lower Limit Mark	F.2.2(a)	19
Half Leech Point (trilateral sails)	G.5.2	31	Lower Point	F.2.1(d)	19
Half Leech Point (other sails)	G.5.2 * <sup>1</sup>	38	Lower Point Height	F.2.3(b)	19
Half Luff Point	G.5.7	32	Luff	G.2.3	29
Half Width	G.7.5	34	Luff Length (trilateral sails)	G.7.3	34
Halyard	F.1.7(b)(i)	18	Luff Length (other sails)	G.7.3 * <sup>1</sup>	39
Head (trilateral sails)	G.3.2	29	Luff Perpendicular	G.7.11	36
Head (other sails)	G.2.5 * <sup>1</sup>	38	<b>M</b>		
Head Length	G.7.12 * <sup>1</sup>	39	Mainsail	G.1.3(a)	27
Head Point	G.4.2	30	Main Boom	F.1.4(b)(iii)	17
Headsail	G.1.3(d)	27	Mainmast	F.1.4(a)(i)	16
Headsail Boom	F.1.4(b)(ii)	17	Major Axes	C.6.3(a)	11
Heel Point	F.2.1(b)	19	Mast	F.1.4(a)	16
			Mast Centre of Gravity Height	F.2.3(q)	22
			Mast Datum Point	F.2.1(a)	19

## INDEX OF DEFINITIONS

Defined Term	Rule	Page	Defined Term	Rule	Page
Mast Length	F.2.3(a)	19	Quarter Width	G.7.4	34
Mast Spar Cross Section	F.2.3(m)	22	<b>R</b>		
Mast Spar Curvature	F.2.3(k)	21	Reinforcement Size	G.8.4	36
Mast Spar Deflection	F.2.3(l)	21	Rig	F.1.1	16
Mast Spar Weight	F.2.3(n)	22	Rigging	F.1.6	18
Mast Tip Weight	F.2.3(p)	22	Rigging Point	F.2.3(d)	20
Mast Weight	F.2.3(o)	22	Rudder	E.1.2(j)	15
Maximum Draft	C.6.4(g)	12	Running Backstay	F.1.7(b)(iii)	18
Measurement Trim	C.6.3(b)	11	Running Rigging	F.1.7(b)	18
Mid Foot Point	G.5.10	32	<b>S</b>		
Minimum Draft	C.6.4(f)	12	Sail	G.1.1	27
Mizzen	G.1.3(c)	27	Sail Corners (trilateral sails)	G.3	29
Mizzen Boom	F.1.4(b)(iv)	17	Sail Corners (other sails)	G.3* <sup>1</sup>	38
Mizzen Mast	F.1.4(a)(iii)	16	Sail Edge Shape	G.1.4(p)	29
Monohull	C.6.2(a)	10	Sail Edges (trilateral sails)	G.2	29
Movable Ballast	C.6.3(e)(iii)	11	Sail Edges (other sails)	G.2* <sup>1</sup>	38
Multihull	C.6.2(b)	10	Sail Leech Hollow	G.2.4	29
<b>O</b>			Sail Opening	G.1.4(l)	28
Official Measurer	C.4.4	9	Schooner Rig	F.1.2(f)	16
Open Class Rules	C.2.3	8	Seam	G.1.4(h)	28
Outhaul	F.1.7(b)(v)	18	Seam Width	G.8.5	37
Outer Limit Mark (boom)	F.3.2(a)	23	Secondary Reinforcement	G.6.2	33
Outer Limit Mark (bowsprit)	F.5.2(b)	25	Set Flying	G.1.2	27
Outer Point	F.3.1(a)	23	Sheer	D.1.3	13
Outer Point Distance	F.3.3(a)	23	Sheerline	D.1.2	13
<b>P</b>			Sheet	F.1.7(b)(vi)	18
Peak	G.3.4 * <sup>1</sup>	38	Shroud	F.1.7(a)(i)	18
Peak Point	G.4.4 * <sup>1</sup>	38	Shroud Height	F.2.3(f)	20
Personal Equipment	C.5.3	10	Single-Ply Sail	G.1.4(f)	28
Personal Flotation Device	C.5.4	10	Skeg	E.1.2(f)	14
Ply	G.1.4(b)	28	Skipper	C.5.2	10
Portable Equipment	C.6.5	12	Sloop Rig	F.1.2(b)	16
Primary Reinforcement	G.6.1	32	Soft Sail	G.1.4(c)	28
<b>Q</b>			Spar	F.1.3	16
Quarter Leech Point	G.5.1	31	Spinnaker Guy	F.1.7(b)(vii)	18
Quarter Luff Point	G.5.6	32	Spinnaker Hoist Height	F.2.3(j)	21

## INDEX OF DEFINITIONS

Defined Term	Rule	Page	Defined Term	Rule	Page
Spinnaker Pole	F.1.4(d)(i)	17	Upper Leech Point (trilateral sails)	G.5.4	31
Spinnaker Pole Fitting Height	F.2.4(b)(i)	23	Upper Leech Point (other sails)	G.5.4 * <sup>1</sup>	38
Spinnaker Pole Fitting Projection	F.2.4(b)(ii)	23	Upper Limit Mark	F.2.2(b)	19
Spinnaker Pole Length	F.4(a)	25	Upper Luff Point	G.5.9	32
Spinnaker Pole Spar Cross Section	F.4(b)	25	Upper Point	F.2.1(e)	19
Spinnaker Pole Weight	F.4(c)	25	Upper Point Height	F.2.3(c)	20
Spreader	F.1.5	18	Upper Width	G.7.7	34
Spreader Height	F.2.4(a)(ii)	22	<b>V</b>		
Spreader Length	F.2.4(a)(i)	22	Variable Ballast	C.6.3(e)(iv)	11
Sprit	F.1.4(d)(vi)	17	<b>W</b>		
Standing Rigging	F.1.7(a)	18	Waterline	C.6.3(c)	11
Stay	F.1.7(a)(ii)	18	Waterline Length	C.6.4(c)	12
Stiffening	G.1.4(n)	28	Waterplane	C.6.3(d)	11
<b>T</b>			Wishbone Boom	F.1.4(b)(v)	17
Tabling	G.6.3	33	Whisker Pole	F.1.4(d)(ii)	17
Tabling Width	G.8.4(b)	36	Whisker Pole Length	F.4(a)	25
Tack	G.3.3	29	Whisker Pole Spar Cross Section	F.4(b)	25
Tack Diagonal	G.7.9(b)	35	Whisker Pole Weight	F.4(c)	25
Tack Point	G.4.3	31	Window	G.1.4(m)	28
Three-Quarter Leech Point (trilateral sails)	G.5.3	31	Window Area	G.8.10	37
Three-Quarter Leech Point (other sails)	G.5.3 * <sup>1</sup>	38	Window Ply Area	G.8.9	37
Three-Quarter Luff Point	G.5.8	32	Windsurfer	C.6.2(c)	10
Three-Quarter Width	G.7.6	34	Woven Ply	G.1.4(d)	28
Throat	G.3.5 * <sup>1</sup>	38	<b>Y</b>		
Throat Point	G.4.5 * <sup>1</sup>	38	Yard	F.1.4(d)(v)	17
Top Point	F.2.1(c)	19	Yawl Rig	F.1.2(e)	16
Top Width	G.7.8	35			
Trapeze	F.1.7(c)(i)	19			
Trapeze Height	F.2.3(i)	20			
Trim Tab	E.1.2(k)	15			
Tuck	G.1.4(j)	28			
Tuck Width	G.8.7	37			
<b>U</b>					
Una Rig	F.1.2(a)	16			

\*<sup>1</sup> See Section G, Subsection B –  
Additions for Other Sails